

Effect of Impulse Voltage on Partial Discharge of Oil and Paper - Oil Insulators Containing Air Cavity

Seyed Mohammad Hassan Hosseini*¹, Roya Shamsali²

^{1,2} Electrical Engineering Department South Tehran Branch, Islamic Azad University Tehran, Iran

Abstract

In power systems, usually by lightning or switching impulse voltage is produced. This paper reviews the impact of impulse voltage on PD parameters. In recent years numerous studies on PD in the insulation, under the impulse has been done. Despite the use of power equipment and tools, keying pulses are created in the system. Studies on PD activity with the initiation and end voltage PD in insulators have been investigated. The PD specification, combined with impact pulse and AC, has not been studied in many studies. Unlike previous studies, here, along with the impulse voltage, the AC voltage effects are also investigated. On the other hand, dielectric characteristics show the quality of insulation in terms of the soundness or deterioration of equipment over time. The deterioration and aging of equipment can be due to electrical stresses such as alternating current PDs or transient stresses. Or due to environmental pressures and temperature or mechanical pressures. At this point, the impact of PD alternating current (AC) on paper combination insulation oil dielectric frequency response equipment been investigated. In this review, while addressing a brief history of the performance of insulation against partial electrical discharge, Maxwell's method of using the finite element software is proposed to simulate partial electrical discharge in objects that are particularly sharp and molded are investigated.

Keywords: Partial Electrical Discharge , Insulation , Oil , Oil Paper, Dielectric Response

1. INTRODUCTION

Electrons and ions which have absorbed energy by partial discharge, locate on the surface of the insulating oil paper, that this energy is absorbed as a result of covalent gap and cell breakdown [1-5]. Created heat through PD cause thermal cell breakdown [1-5]. Hence, polymer free radicals that are charged electrically, gain energy in the PD process [1-2]. As a result of free radicals increasement, specific conductivity of oil

conductor become more than paper conductor and also carbon dependent on paper conductor increases step by step which cause increasement

of paper special conductivity [1]. When free radicals stimulate further, the temperature of oil paper insolation increases and after that special conductivity of insolation increases. Special conductivity of oil is more than paper [6-7], in other words paper permittivity is more than oil. Hence, when it is exposed to electrical stresses, loads cross of oil phase better than paper phase. Hence, oil insulation response is different from paper and

*Corresponding Author's Email: smhh110@azad.ac.ir

when insulation is oil-paper the sum of obtained

answers is a mixture of their responses [1].

2.RESULTS OF TESTS AND SCRUTINY

Table. 1. Summary of done tests

Number of samples	Description	Study
1	PD measurement: Destructive effect of PD in highlighted periodic voltages in range of more than 5 hours	1
2	PD measurement: Effect of high tension impulses	2
3	PD measurement: Effect of a mixture of 4 high tension impulses and be destroyed because of PD under the influence of AC alternating voltages in range of 5 hours	3
1, 2,3	DS measurement: Safety of test sample for 2 different times (4 samples) sample 1 (safety time and after test in first study) and samples 2 and 3 after test in 2 and 3 studies	4

1.2.PD Measuring System

PD measuring system is shown below.

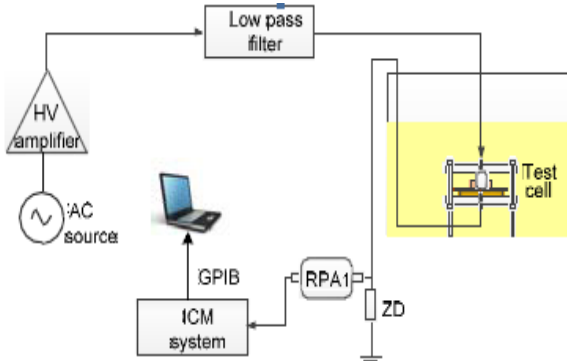

Fig. 1. Schematic diagram of PRPD measuring System .

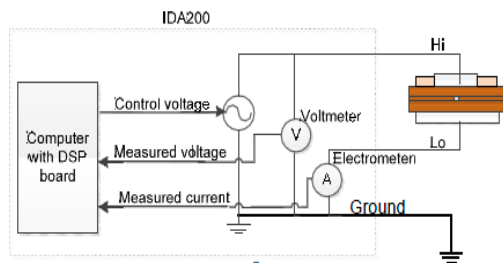

Fig3. Schematic diagram of spectrometric measuring system.

Main components are:

AC source of HV amplifier low pass filter, case of test, wave impedance Zs, monitoring insulator position, ICM system and a computer that is represented under its schematic diagram [8].

3.PD PARAMETERS VARIATION OF OIL PAPER INSULATION BY AIR CAVITY AT APPLYING AC VOLTAGE TIME AND IMPULS

1.3.Applying Ac Voltage

Applied AC voltage has the pick equal to 16 (KV¹) that is applied in period of 5 hours. Early voltage equals to PD (KV)⁶. System saves sample's PRPD measures every 5 minutes.

The average of PD numbers increases by increase in rate of equipment's oldness until reaches 180 minutes. Then, the average of OD numbers decreases.

3.2.Effect Of Hv Impuls Voltage On Pd

In this study, tested sample will be under impulse voltage equal to 1, 2.50 for times by pick equal to 80 (KV). That PRPD² equipment records samples before and after each four times.

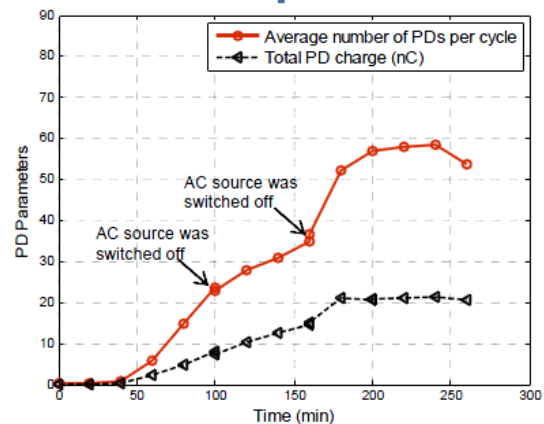

Fig3. PD parameters in period of applying AC voltage.

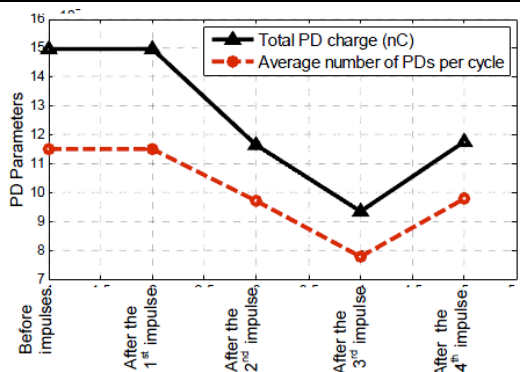

Fig4. PD parameters before and after applying impulse voltage .

In spite of first case that amplitude of PD parameters are in the same direction, in impulse voltage the amplitude of PD parameters fluctuates between two impulses.

3.3. Combination of Applying Ac Voltage

In this part by applying both AC and impulse voltage, PD will be studied.

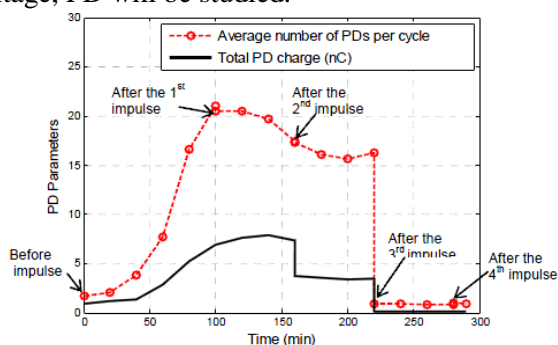

Fig5. PD parameters before and after applying AC voltage and impulse .

It is considered that PD parameters after applying third impulse decrease a lot and till the end of test remain in that low and constant level. After doing this test, the surface of cavity and inside it, become carbon and black but in two previous tests it didn't happen [4].

3.4. Symmetry in PD

All recorded PD samples in half positive and negative cycles are symmetric. Image of PD after 5 and 18 hours is represented below as an example. As it is obvious in images, in half positive and negative cycles, samples are symmetric, PD sam-

ples symmetry in half positive and negative cycles show the beginning of insulation destruction process. After 18 hours of PD process, a sign of PD creation in air cavity in the middle of oil paper insulation appears [22].

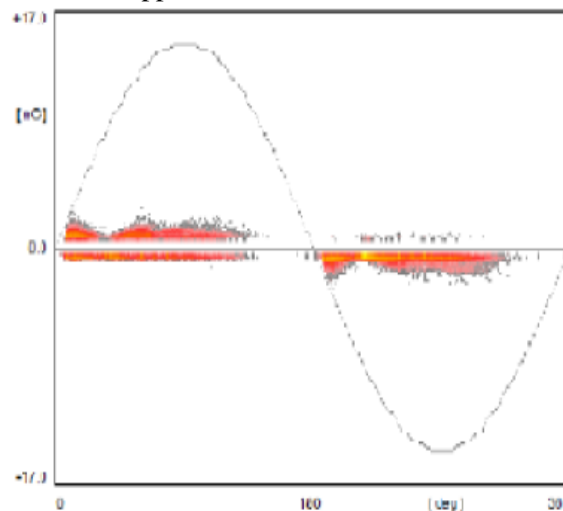

Fig6. PD after 5 hours.

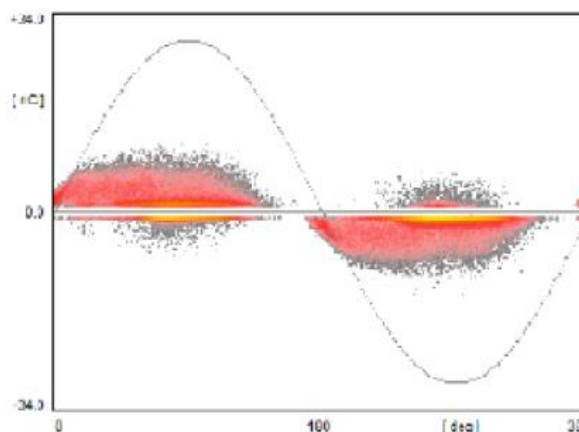

Fig7. PD after 18 hours.

3.5. Parameters of Insulation Diagram After Pd

Loss coefficient decreases by frequency increase and after applying voltage and PD creation loss pick appears. Amplitude of loss coefficient by increasing time duration of applying voltage, especially for frequencies less than 100Hz increase.

Loss pick on the surface of oil paper insulation increases because the maximum insulation parameters difference (loss coefficient and permittivity) is the edge of these two insulation.

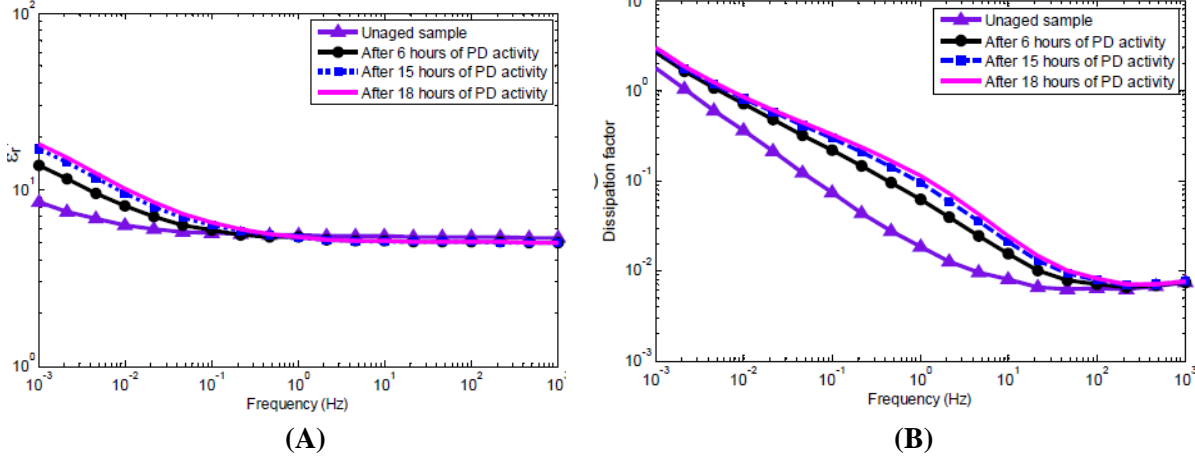

Fig8. Results of spectrometry of oil pregnant paper dielectric at the time of safety and after applying AC voltage .

A)Real part of relative complex permittivity B)Loss coefficient .

According to figure after applying periodic PD in the range of low frequency, the amplitude of PD increases.

3.6. Effect of PD on Existed Oil In Transformer

By using the results of ASTM¹ test, it is possible to obtain loss coefficient dielectric (DDF) and special conductivity of insulation matter by applying a voltage by frequency equal to 0.1 to 1000Hz² that it is considered that by applying voltage both properties increase.

As it is considered by increasing the free radicals the amount of DDP³ increases [5]. By air entering air to oil, oil become oxidized, so-called gassy and causes increasement in free radicals in the space around the cavity and causes creation of sticky matter in transformer oil countainer.

However this material prevents porous creation in paper, prevents heat transmission and decreases heat transmission power and causes free radicals increasement and conductivity increasement and conducts the insulation.

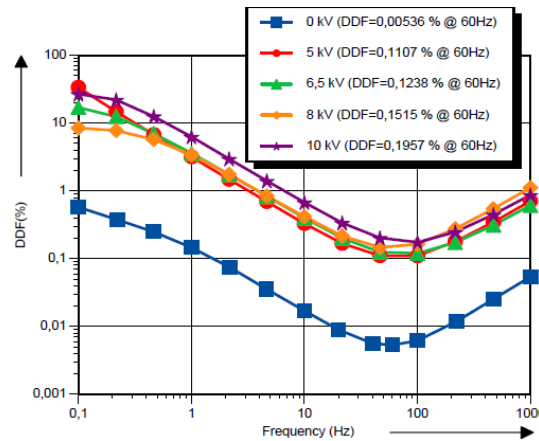

Fig9. Oil DDF frequency scan before and after applying voltage .

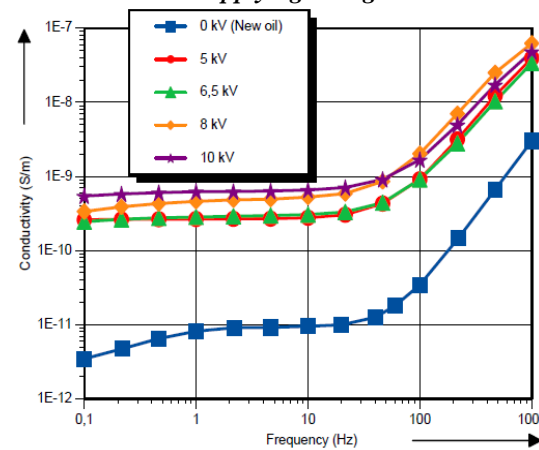

Fig10. Oil special conductivity frequency scan before and after applying voltage .

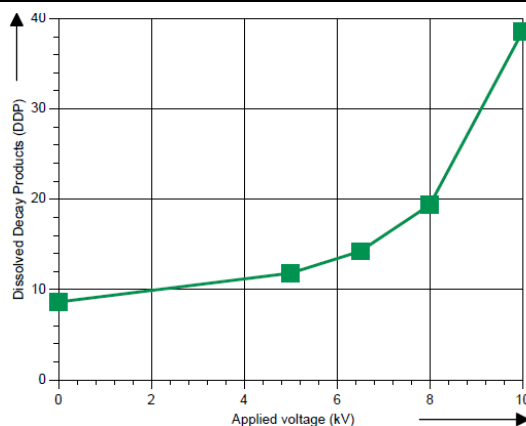

Fig11. Equipment destruction depends on applied voltage on it

Table. 2. Turbidity Assessment of Oil Befodre and After Voltage Application.

	After Applying Voltages(kv)				
	Fresh oil	5	6.5	8	10
Turbidity (NTU)	0.49	0.65	1.08	1.34	1.47

It is considered that sticky matter after applying voltage increases. Actually this chart is a standard for measuring the oil purity rate which is used in transformers.

IFT¹ oil interfacial force tension is being used that is a standard for measuring the oil purity rate. The amount of existed acid in oil which is created by heat, which gradually creates sticky matter, is measured based on the standard and by applying voltage, this acidic matter increases. The rate of increasement in 10(KV) reaches 19.2(dynes/cm) that means the quality of the oil is not appropriate.

4.SIMULATION USING FEM MODEL

In this part, oil paper system simulation by infinit eleman model, has been shown. By using it, field variation, voltage and flux and even flux density can be obtained.

Since in this system, oil paper insulation is considered constant and no transmission is applied on it, a 2D (Two-dimensional) system is used for simulation. Nevertheless by considering transmission and Transient type of analysis, 3D

model (Three-dimensional) should be used, , but program performance would be time consuming.

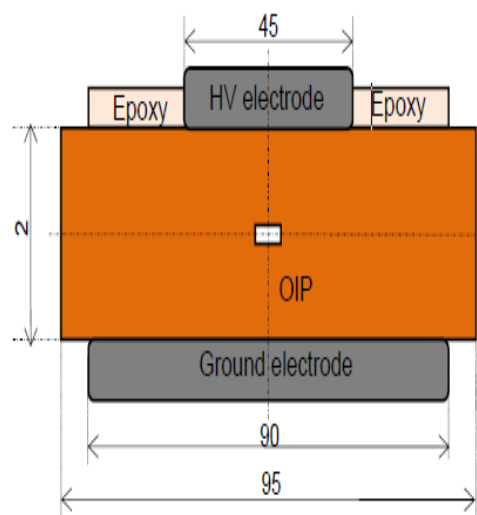

Fig.12 توضیح را بنویسید

Existed figure in reference [8] that is simulated by Comsol software, here is simulated by Maxwell.

1)First, the green rectangle (paper insulation) is designed by below dimension. (according to existed dimension in source [1])

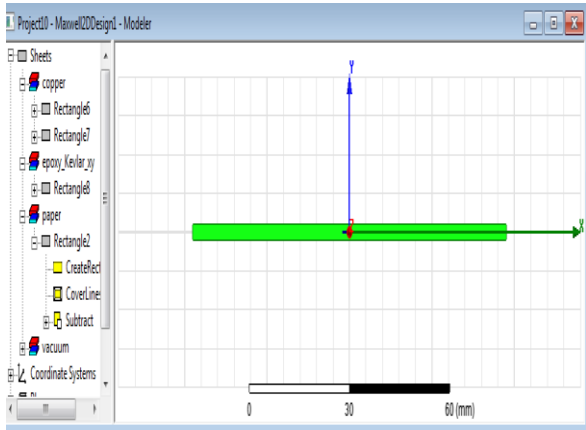

Fig13. Paper insulation.

2)Then, electrodes are drawn.

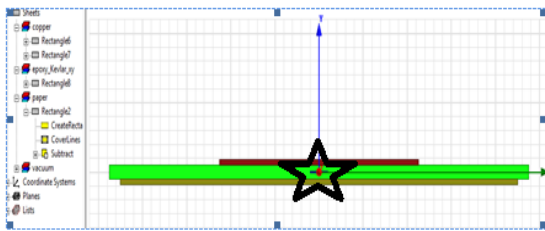

Fig14. Electrodes.

By dimension:

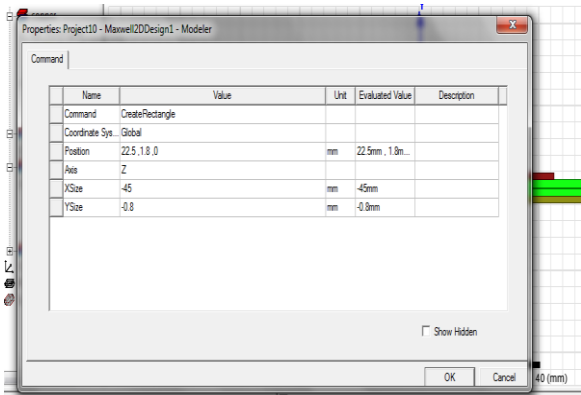
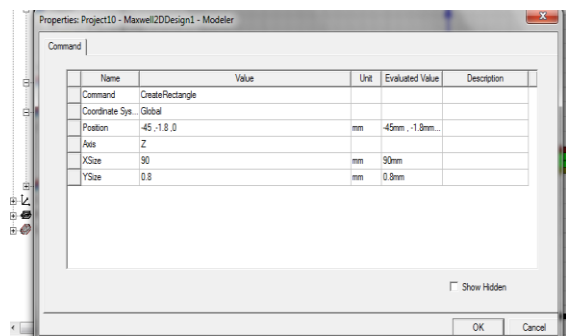

Fig15. Electrodes dimension



3)In this step, as it is mentioned in the paper, the tip of electrodes should be Epoxy. Hence, epoxy of electrodes tip is drawn.

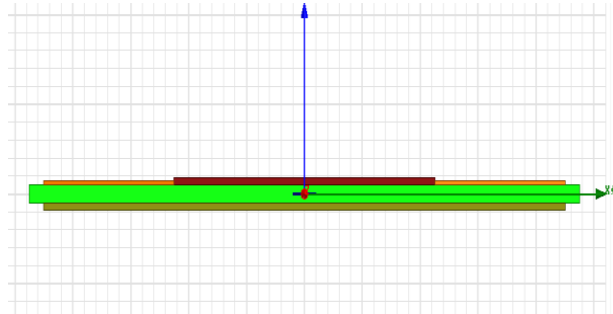

Fig16. Epoxies (orange).

4)In this step, the empty cavity space full of air should be created. For this purpose, a rectangle with the mentioned below dimension should be created and reduce it from paper insulation space.

As a result, a cavity is created in the center that is specified by star.

5) In this step, excitations are created (1).

By specifying Setup and the type of solving problem analysis, the steps of designing are being checked.

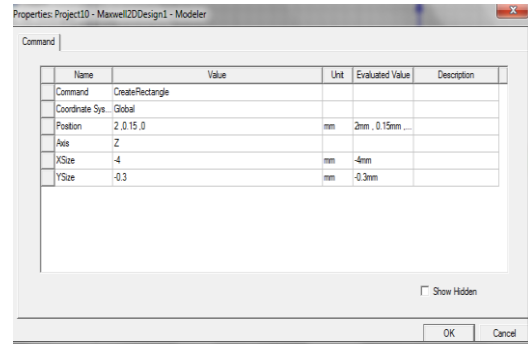

Fig17. Rectangle's dimension.

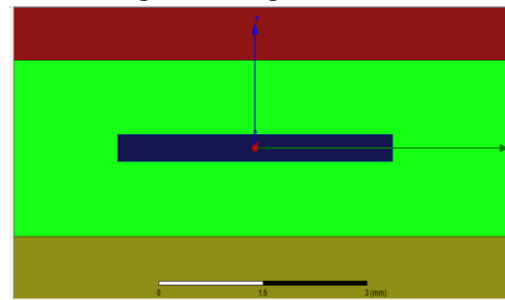

Fig18. Cavity.

By confirming all steps, now it's time to obtain voltage analysis and other parameters. Hence, select all spaces then right click and as the result according to system analysis, in the voltage around 8(KV) PD happens in the cavity.

5.CONCLUSION

partial electrical discharge can be easily analyzed by infinite element software (MAXWELL). Using design tools, most of dangerous infinite discharges that happen and cause serious damages to expensive and structure complex equipments, can be simulated and analyzed in different regions of the model which has important sharpness or ice that cause non-uniform fields. In this way, it is possible to resolve one of the fundamental problems of simulating infinite electrical discharge that is mentioned in source [9], and also the speed and accuracy of analysis increase and the problems related to sensitive and sharp regions also can be resolved.

REFERENCES

- [1] C.Homgak, K. Mossner and T Leibfried, "Investigation on degradation of power transformer solid insulation material", IEEE 78, 2008.
- [2] K.Dumke, H. Boris and E. Cockenbach, "Experimental investigation on the behavior of decomposition gases in insulation liquids caused by partial discharge and breakdown", Int'l. conf conduction and Breakdown, Dielectr. Liquids, Roma, pp. 436- 439, 1996.
- [3] J. Yan, R. Liao, L. Yang, J. Li and B Liu "product analysis of partial discharge damage to oil – impregnated insulation paper". J. Appl, surface Sci, Vol, 257, pp. 5863-5870, 2011.
- [4] Sbau and R Stokhuyzen, "the side effects of gasinng in transmission power transformers "IEEE, conf Electr. Insul. Dielectr. Phenomena (CEIDP), Victoria, BC, Vol. 1, pp, 264-7267, 2000.
- [5] J.S N'cho, T Aka – Ngnui, A Beroual and I. Fon Fofana "Effect of electrical discharge on oil decaying process.
- [6] M. Kohtol, S Kaneko, S Okabe and T Amimoto "Aging effect on electrical characteristics of insulation oil in field transformer".
- [7] SM. Gubanski, P. Boss, G. Csepes, V Der Houhanwsian" dielectric response method for diagnostics of power transformer".
- [8] R. Clemen kiza, M. Ghaffarian Niasar, R. Nikjoo, X. Wang & H. Edin "The effect of partial discharge by – products of the dielectric frequency response of oil – paper insulation comprising of a small cavity"
- [9] R. Clement Kiza, R. Nikjoo, M. Ghaffara Niasar, X. Wang &H Edn "effect of high voltage impulse on partial discharge acivity in a cavity embedded in paper insulation".
- [10] jialu Cheng, Diego Robalino, peter Wereilius, Matz ohlen" improvement of the transformer insulation XY model including effect of contamination".
- [11] M. Koch and T. Pre vost "Analysis of dielectric response measurement for condition assessment of oil – paper transformer insulation", IEEE Trans. Dielectr. Electr. Insul, vol. 19. Pp. 1908-1915, 2012.
- [12] M.Jaya, T.Leibrried and M. Koch "Information within the clielectric response of power transformers for wide frequency ranges" IEEE 2010.
- [13] S.M.Gubnski, P.Boss, G.Csepes, V.Der Houhanesian, J.Rilippini, P.Guainic, U.Gafvert, V.Karius, J.Lapworth, G.urbanic, UL.Gafvert, V.Karius, J.Lapworth, G.Urbani, P.Werelius and W.Zaengle "Dielectric response methods for diagnostics of power transformer" IEEE 2003.
- [14] j.Sabau and R.Stokhuyzen "The electrochemical stability of mineral insulating oils" Electricals Insulating Materials America Society of Testing and Materials, 2000.

- [15] Astm 0971, Standard Tost Method for Interfacial Tension of Oil Against Water by the ring Method Vol.10.03.